



**Outil rapide et sûr pour
le soulagement de traction**



TIRE-CÂBLES en version galvanisé et inoxydable

« ECO » avec 1 boucle

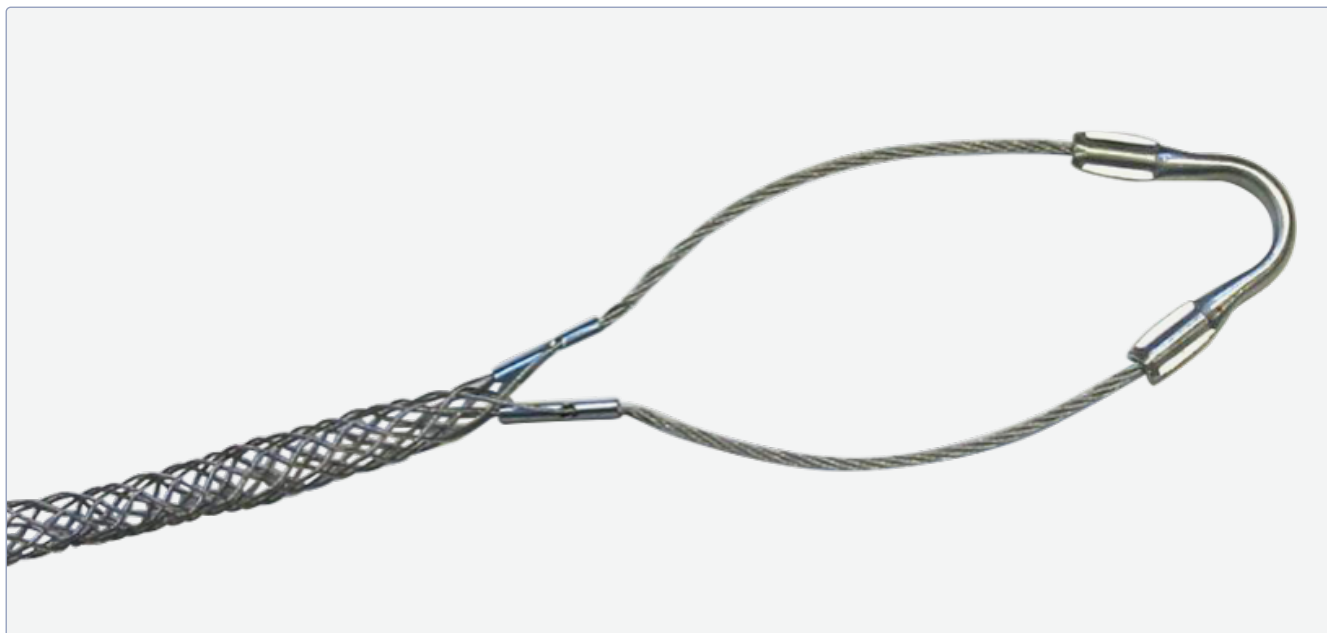



















Tire-câbles

Les tire-câbles, également appelés manchons de montage, constituent un outil sûr et rapide pour la suspension préservatrice et le soulagement de traction des câbles et des lignes.

Grâce à la tresse flexible, la force de tension exercée par le manchon de retenue est transmise sur un long tronçon de câble. Avec les manchons de retenue de câble, la charge ponctuelle qui entraîne trop facilement des ruptures de fils dans la fixation usuelle par collier de câble est exclue.

Les manchons de retenue de câbles sont utilisés pour la fixation de câbles sur des transformateurs extérieurs, installations d'antennes, installations mobiles telles que ascenseurs, grues, etc.

Également disponibles en acier inoxydable.

	Type	N° d'article	Zone (mm)	Force de traction (kN)	Prix CHF par pce.
L	SPJ023U	00908401	5.8 - 7.9	1'290	36.50 
L	SPJ029U	00908402	7.4 - 9.4	1'290	37.70 
L	SPJ035U	00908403	8.9 - 11.2	2'224	41.30 
L	SPJ041U	00908404	10.4 - 12.7	2'224	41.30 
L	SPJ046U	00908405	11.7 - 14.2	2'936	46.50 
L	SPJ052U	00908406	13.2 - 15.8	3'514	52.70 
L	SPJ058U	00908407	14.7 - 17.3	3'514	55.50 
L	SPJ064U	00908408	16.3 - 19.1	3'514	55.50 
L	SPJ075U	00908409	19.1 - 22.1	4'537	56.40 
L	SPJ087U	00908410	22.1 - 25.4	4'537	59.30 
L	SPJ100U	00908411	25.4 - 30.0	4'537	59.30 
L	SPJ106U	00908412	26.9 - 31.8	4'537	61.40 
L	SPC125U	00908413	31.8 - 37.9	7'161	106.60 
L	SPC150U	00908414	38.1 - 44.2	7'161	117.00 
L	SPC175U	00908415	44.5 - 50.6	9'563	151.90 
L	SPC200U	00908416	50.8 - 63.3	14'500	182.50 
L	SPC250U	00908417	63.5 - 76.0	14'500	208.50 
L	SPC300U	00908418	76.2 - 88.7	21'795	348.00 
L	SPC350U	00908419	88.9 - 101.4	21'795	352.00 

L *Livraison de suite, en stock • Prix hors TVA • Livraison départ Samstagern

« ECO-TWIN » avec 2 boucles

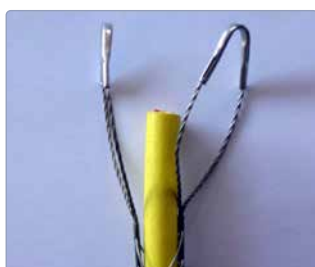
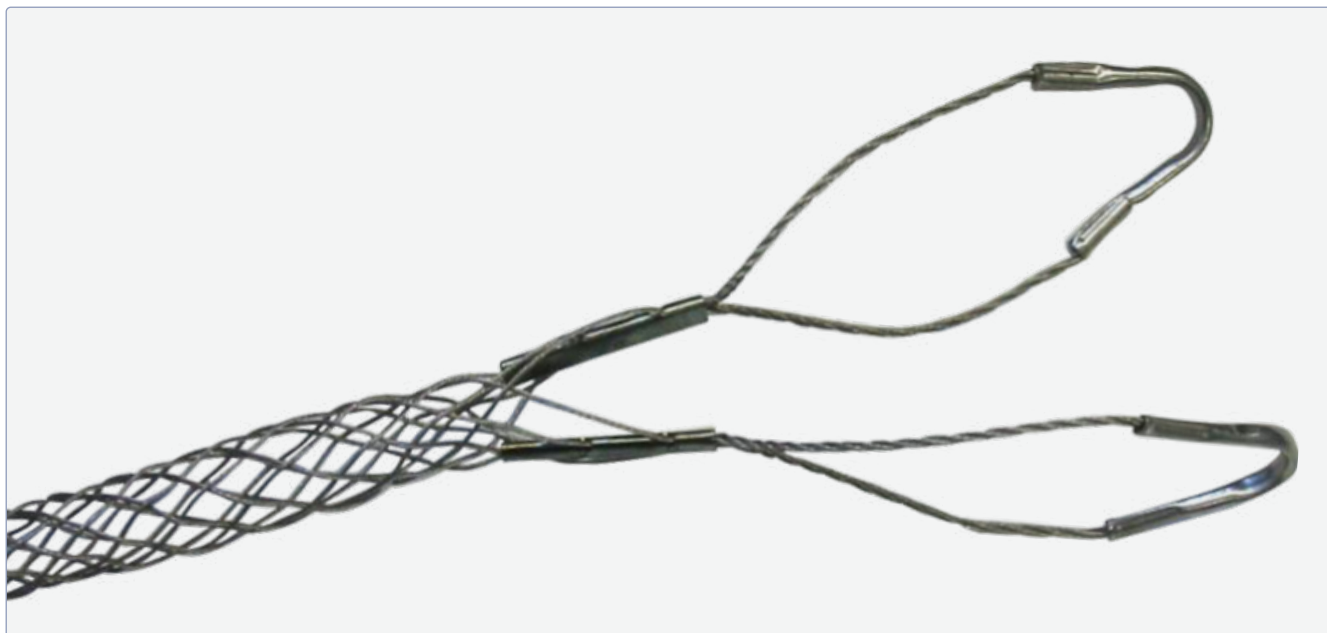

Tire-câbles

Les tire-câbles, également appelés manchons de montage, constituent un outil sûr et rapide pour la suspension préservatrice et le soulagement de traction des câbles et des lignes.

Grâce à la tresse flexible, la force de tension exercée par le manchon de retenue est transmise sur un long tronçon de câble. Avec les manchons de retenue de câble, la charge ponctuelle qui entraîne trop facilement des ruptures de fils dans la fixation usuelle par collier de câble est exclue.

Les manchons de retenue de câbles sont utilisés pour la fixation de câbles sur des transformateurs extérieurs, installations d'antennes, installations mobiles telles que ascenseurs, grues, etc.

Également disponibles en acier inoxydable.

	Type	N° d'article	Zone (mm)	Force de traction (kN)	Prix CHF par pce.
L	SPC050DE	00908420	12.7 - 15.8	2'357	79.70
L	SPC062DE	00908421	16.0 - 18.8	3'514	87.70
L	SPC075DE	00908422	19.1 - 25.2	4'537	96.30
L	SPC100DE	00908423	25.4 - 31.5	7'161	97.50
L	SPC125DE	00908424	31.8 - 37.9	7'161	118.80
L	SPC150DE	00908425	38.1 - 44.2	7'161	123.00
L	SPC175DE	00908426	44.5 - 50.6	9'563	148.20
L	SPC200DE	00908427	50.8 - 63.3	14'500	183.00
L	SPC250DE	00908428	63.5 - 76.0	14'500	235.00
L	SPC300DE	00908429	76.2 - 88.7	21'795	235.00
L	SPC350DE	00908430	88.9 - 101.4	21'795	272.00

L *Livraison de suite, en stock • Prix hors TVA • Livraison départ Samstagern

« HEAVY » Modèle standard en acier zingué et inoxydable

Modèle standard en acier zingué













Tire-câbles

Les tire-câbles, également appelés manchons de montage, constituent un outil sûr et rapide pour la suspension préservatrice et le soulagement de traction des câbles et des lignes.







Grâce à la tresse flexible, la force de tension exercée par le manchon de retenue est transmise sur un long tronçon de câble.

Avec les manchons de retenue de câble, la charge ponctuelle qui entraîne trop facilement des ruptures de fils dans la fixation usuelle par collier de câble est exclue.

Les manchons de retenue de câbles sont utilisés pour la fixation de câbles sur des transformateurs extérieurs, installations d'antennes, installations mobiles telles que ascenseurs, grues, etc.

	Désignation	N° d'article	Câble-Ø (mm)	Longueur de manteau (mm)	Force de traction (kN)	Modèle de cosse	Prix CHF par pce.
L	MIB-210-1250-V	00908432.8	8 - 15	1250	5.12	2 x R	184.00 
L	MIB-215-600-V	00908432.4	15 - 20	600	7.92	2 x R	116.00 
L	MIB-215-1000-V	00908432.6	15 - 20	1000	7.92	2 x R	185.00 
L	MIB-215-1200-V	00908432.7	15 - 20	1200	7.92	2 x R	195.00 
L	MIB-220-600-V	00908432.5	20 - 30	600	31.92	2 x R	121.00 
L	MIB-225-600-V	00908433	25 - 30	600	31.92	2 x H	134.00 
L	MIB-225-700-V	00908434	25 - 30	700	31.92	2 x H	138.00 
L	MIB-230-600-V	00908437	30 - 40	600	28.6	2 x H	145.00 
L	MIB-240-600-V	00908470	40 - 50	600	28.6	2 x H	147.00 
L	MIB-240-1250-V	00902401250V	40 - 50	1250	21.36	2 x H	155.00 
L	MIB-260-600-V	00908438	60 - 80	600	40.5	2 x H	219.00 
L	MIB-670-700	00908670	70 - 80	700	25.6	1 x R	247.00 
L	MIB-680-700	00908680	80 - 100	700	28.8	1 x R	298.00 

Modèle standard en inox

	Désignation	N° d'article	Câble-Ø (mm)	Longueur de manteau (mm)	Force de traction (kN)	Modèle de cosse	Prix CHF par pce.
L	MIB-610-H-300-N	00908445	8 - 15	300	5.12	1 x D	63.00 
L	MIB-615-700-N	00908461	15 - 20	700	1.46	2 x H	142.00 
L	MIB-715-H-700-N-V	00908448	15 - 20	700	6.4	2 x D	198.00 
L	MIB-620-H-500-N	00908441	20 - 30	500	6.4	1 x D	112.00 
L	MIB-220-1250-N	00908466	20 - 30	1250	22.3	2 x R	268.00 
L	MIB-220-1250-N-V	00908463	20 - 30	1250	22.3	2 x H	274.00 
L	MIB-630-H-500-N	00908633	30 - 40	500	8.96	1 x D	135.00 

R = Causeries en forme d'anneau
 H = Cosses en forme de cœur
 D = Patte de fil

Ceci n'est qu'une petite partie de notre large gamme de produits pour le soulagement de traction de câbles. Grâce à notre production flexible, nous sommes en mesure de produire des tire-câbles ou manchons de tirage bientôt en version acier ou inoxydable V2A/V4A.

L *Livraison de suite, en stock • Prix hors TVA • Livraison départ Samstager

Plage de serrage de 5.5 à 32 mm

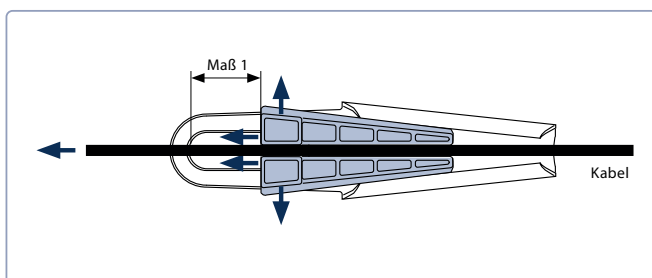

Mâchoires ouvertes

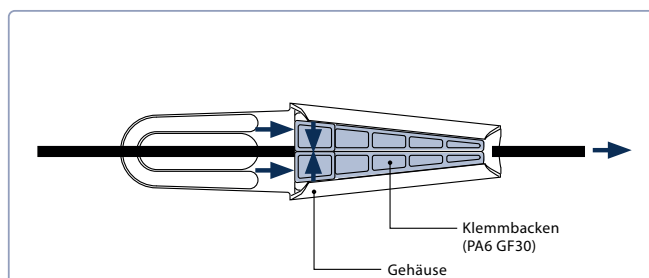

Serrage du câble sous contrainte de traction

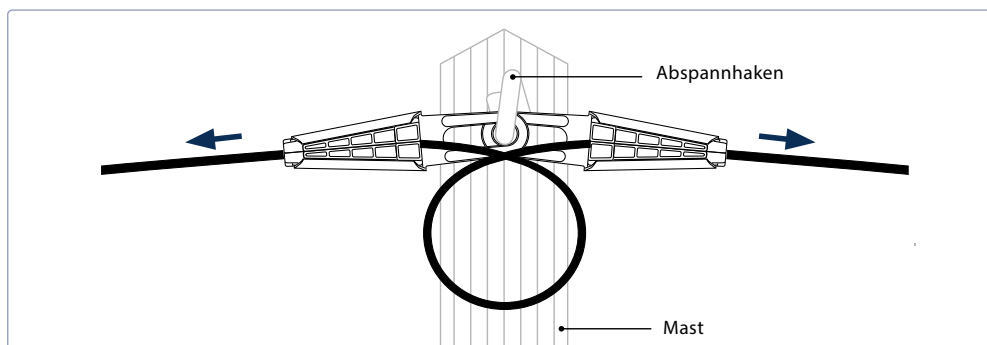







Pincettes de tension fixées au mât

La description

Haubanage léger et fiable de câbles d'installation sur des poteaux et murs de bâtiments

Boîtier en acier zingué avec deux vis coniques en plastique.

Mâchoires de serrage avec blocage en cas de traction du câble.

	Typ	N° d'article	pour câbles Ø mm	Charge de traction admissible (kN)		L x l mm	Prix CHF par pce.
L	MIB-XS	009591440	5.5 - 9.5	2.5	0.15	190 x 48	14.50 
L	MIB-S	009591442	8.5 - 13.5	3.5	0.40	250 x 67	22.00 
L	MIB-M	009591444	12.5 - 17.5	4.5	0.70	300 x 80	26.90 
L	MIB-L	009591446	16.5 - 24	7.5	1.50	420 x 116	60.50 
L	MIB-XL	009591448	22.5 - 32	11.0	3.00	540 x 150	95.50 

L *Livraison de suite, en stock • Prix hors TVA • Livraison départ Samstagen



APPLICATIONS À TAMBOUR



INSTALLATION DE TRANSPORT



STATION D'ÉPURATION ARA

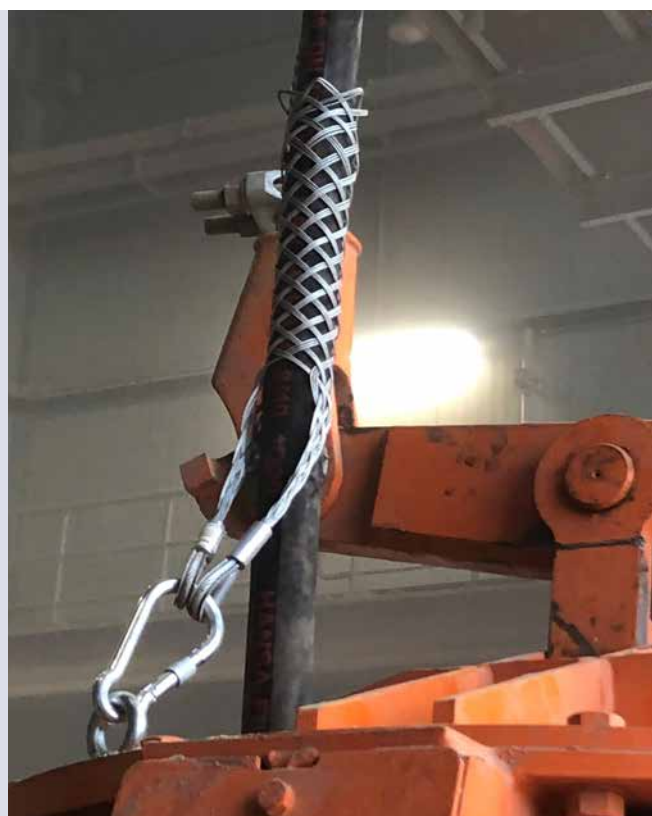

GRAPPIN